

Notes: -
 For marine applications, use a silicone sealant or a bedding compound to avoid electrolytic action between the cleat and metal fastenings.

Standard rivet gun nozzles do not fit inside cleat.

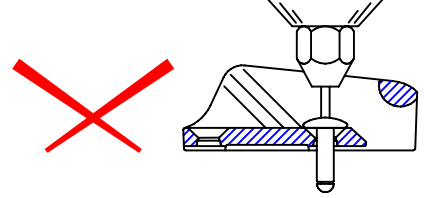

Use 2 or 3 nuts to extend nozzle.

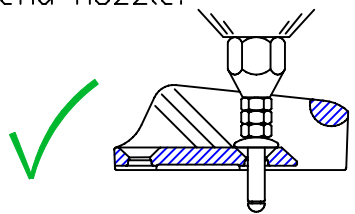

Extended nozzle is best
 Consult rivet gun supplier.

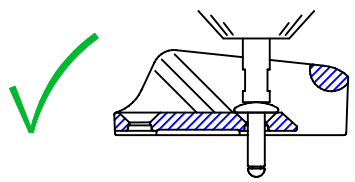

2 Holes $\phi 4.9$
 countersunk $\phi 10.0 \times 90^\circ$

Section 'AA'

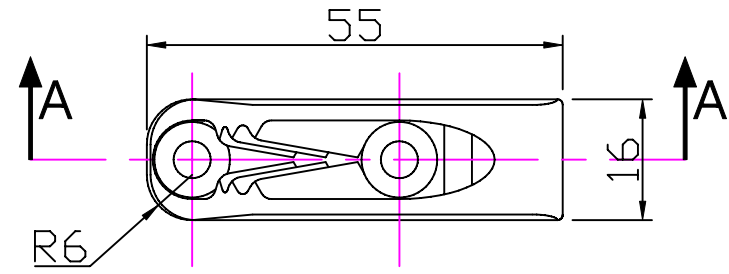
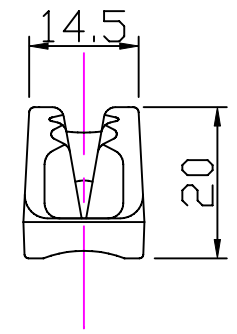
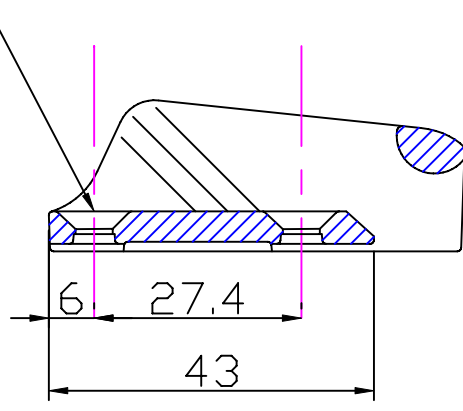
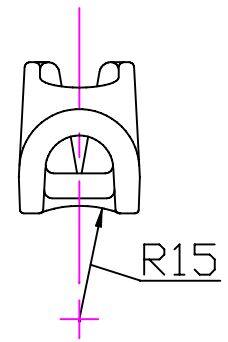

Clamcleat®
 Rope cleats

Clamcleats Limited
 Watchmead
 Welwyn Garden City
 Hertfordshire AL7 1AP
 England

Telephone +44 (0)1707 330101
 Fax +44 (0)1707 321269
<http://www.clamcleat-rope-cleats.com>

Scale 1:1
 All dimensions in mm.

Issue: 5. May 2006
 ID2112.dwg

Material:
 Diecast Aluminium

Installation Drawing for:-
CL211 Mk.2
 Mk2 Racing Junior